



NTSC U/C

PlayStation

RAYMAN → RUSH



SLUS-01458



WARNING: READ BEFORE USING YOUR PLAYSTATION® GAME CONSOLE.

A very small percentage of individuals may experience epileptic seizures when exposed to certain light patterns or flashing lights. Exposure to certain patterns or backgrounds on a television screen or while playing video games, including games played on the PlayStation game console, may induce an epileptic seizure in these individuals. Certain conditions may induce previously undetected epileptic symptoms even in persons who have no history of prior seizures or epilepsy. If you, or anyone in your family, has an epileptic condition, consult your physician prior to playing. If you experience any of the following symptoms while playing a video game – dizziness, altered vision, eye or muscle twitches, loss of awareness, disorientation, any involuntary movement, or convulsions – IMMEDIATELY discontinue use and consult your physician before resuming play.

WARNING TO OWNERS OF PROJECTION TELEVISIONS:

Do not connect your PlayStation game console to a projection TV without first consulting the user manual for your projection TV, unless it is of the LCD type. Otherwise, it may permanently damage your TV screen.

USE OF UNOFFICIAL PRODUCT:

The use of unofficial products and peripherals may damage your PlayStation game console and invalidate your console warranty.

HANDLING YOUR PLAYSTATION DISC:

- This compact disc is intended for use only with the PlayStation game console.
- Do not bend it, crush it or submerge it in liquids.
- Do not leave it in direct sunlight or near a radiator or other source of heat.
- Be sure to take an occasional rest break during extended play.
- Keep this compact disc clean. Always hold the disc by the edges and keep it in its protective case when not in use. Clean the disc with a lint-free, soft, dry cloth, wiping in straight lines from center to outer edge. Never use solvents or abrasive cleaners.

CONTENTS

STARTING THE GAME	2
IN-GAME CONTROLS	3
A) ANALOG CONTROLLER	3
B) GAME CONTROLS	4
NAVIGATING THROUGH THE MENU	5
A) MAIN MENU	5
1. Start a New Game	5
2. Load an Existing Game	6
B) OPTION MENU	6
1. Analog Controller	6
2. Sound	6
STORYLINE	7
GAME RULES	8
A) GENERAL	8
B) GAME MODE DESCRIPTIONS	9
PLAY IN SINGLE-PLAYER OR MULTIPLAYER	12
A) RAYMAN RUSH CHARACTERS	12
1. Character Descriptions	12
2. Character Selection	14
B) SINGLE-PLAYER GAME	14
1. Map Selection	14
2. Game Mode Selection	14
C) MULTIPLAYER GAME	15
1. General	15
2. Levels Settings	15
CREDITS	16
TECHNICAL SUPPORT	22

➔ **STARTING THE GAME**

Set up your PlayStation® game console according to the instructions in its Instruction Manual. Make sure the power is off before inserting or removing a compact disc. Insert the Rayman® Rush disc and close the disc cover. Insert game controllers and turn on the PlayStation game console. Follow on-screen instructions to start a game.

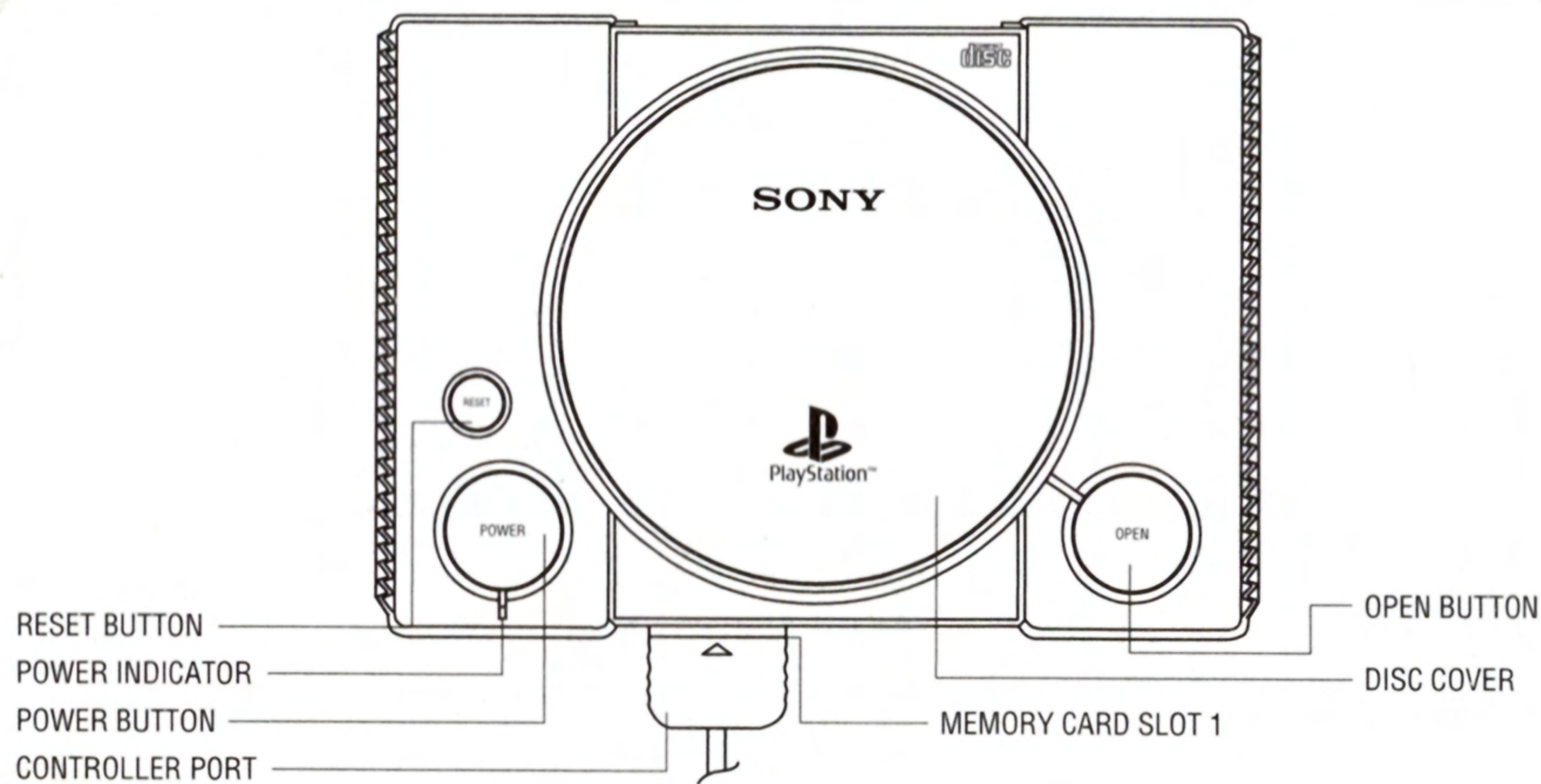

➔ **IN-GAME CONTROLS**

A) ANALOG CONTROLLER

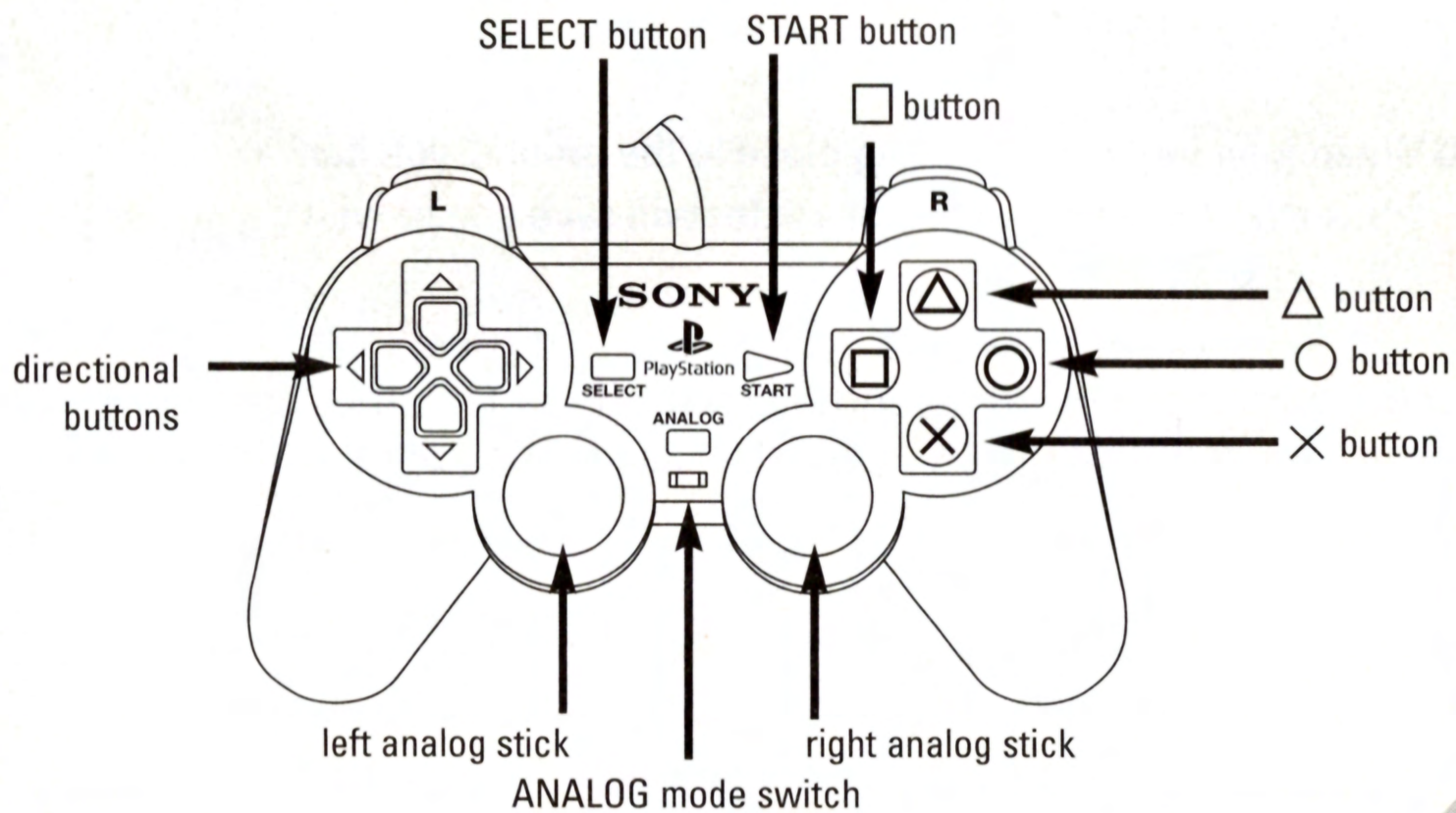
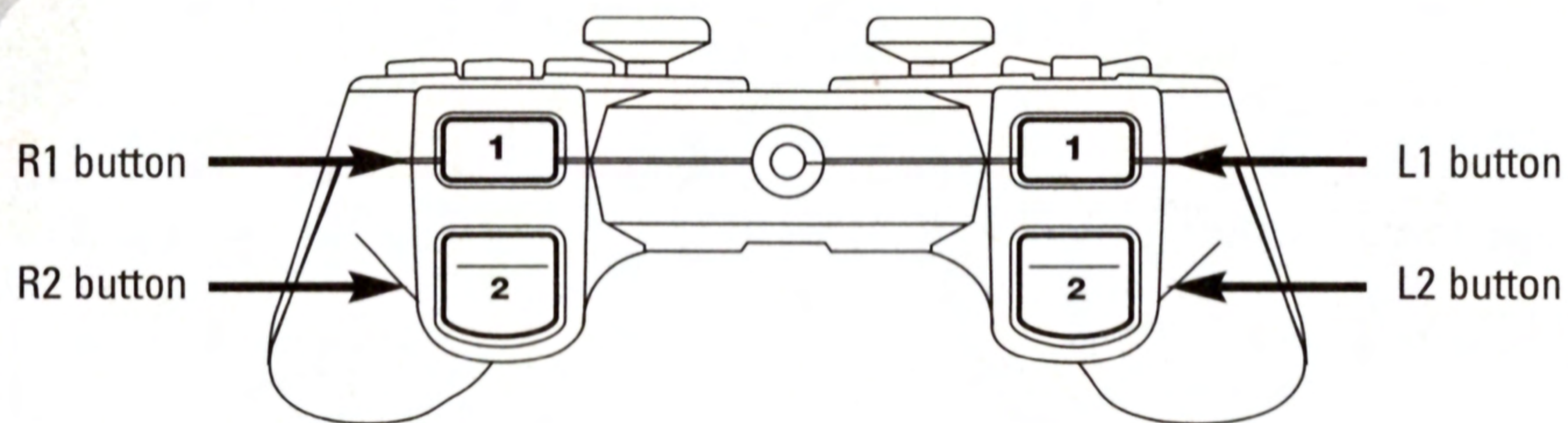

B) GAME CONTROLS

- *To move around*, use directional buttons or left analog stick.
- *To jump*, press the × button.
- *To shoot*, press the □ button.
- *To perform an optimize action*, press the △ button, or push the right analog stick in any direction.

SPECIAL ACTIONS:

- When jumping and remaining close to the ground, you can press the △ button, and the character will race ahead with a higher speed.
- When running onto accelerating plates, you can press the △ button, and the character will get an additional speed-up.
- When stunned, you can press the △ button continuously and rapidly, and the character will recover faster.
- To pause the game, press the START button. The PAUSE Menu appears.

A faint, grayscale background image of the character Rayman from the game Rayman Rush. He is shown from the chest up, wearing his signature white and blue outfit with a large white collar. He has a neutral expression and is looking slightly to the right.

NAVIGATING THROUGH THE MENU

A) MAIN MENU

Use the **LEFT** and **RIGHT** directional buttons or the left analog stick to navigate through the Rayman Rush menus and select slices. Your selection will be highlighted.

Press the **×** button to confirm your selection.

Press the **L1** and **R1** buttons to move from one disk to another.

Press the **△** button to cancel your selection or to return to the menu.

Use the **UP** and **DOWN** directional buttons or the left analog stick to increase or decrease certain values e.g. the **MUSIC VOLUME**.

START A NEW GAME

Select **New Game** if you do not have any previous files stored or if you want to create a new one. Validate by pressing the **×** button.

You subsequently enter the file creation page. You will be asked if you want to create a new game. If you choose **YES** you will access the file creation menu where you can assign a name to the file. Use the directional buttons to compose the name. Validate a letter by pressing the **×** button.

Press the **△** button to delete a letter or to return to the Main Menu.

Once you have entered the name, highlight **OK** and press the **×** button to validate and proceed to the game menu.

After playing a new game, you can save the file on your MEMORY CARD. To do so, please make sure that the MEMORY CARD is inserted into the MEMORY CARD slot 1. Save your profile before commencing playing: Select "Save" and press the × button to confirm.

⇒ LOADING AN EXISTING GAME

Select the continue Slice(Load Game) and confirm by pressing the × button. You subsequently enter a window with a list of previously saved games. Select the game you want to load with the directional buttons and validate by pressing the × button before proceeding to the Game Menu (or press the △ button to return to Main Menu).

B) OPTION MENU

- **Display:** Tune your screen setting using the LEFT/RIGHT directional buttons or the left analog stick. Validate by pressing the × button.
- **Analog Controller:** You can choose the button settings for a single-player game or a multiplayer game. Validate by pressing the × button.
- **Sound:** Adjust music volume, sound effect volume, mono, or stereo sound.

- **Pause Menu:** During the game, you can press the START button to enter the Pause menu, which enables you to:
 - Return to Main Menu
 - Restart the Map
 - Enter the Option Menu
 - Resume Game ⇒

Validate by pressing × button.

STORYLINE

Rayman and his famous friends face new challenges in a unique sporting competition: they will confront each other in tough and varied environments to become THE winner of a surprising Race competition. Pick your character and compete with your opponents within interactive environments filled with power-ups, extreme action and intense shooting. The best player is the one who learns to take advantage of the interactive environment, outdistance themselves from others, and win the competition.

At last, you may succeed
in outwitting Rayman...

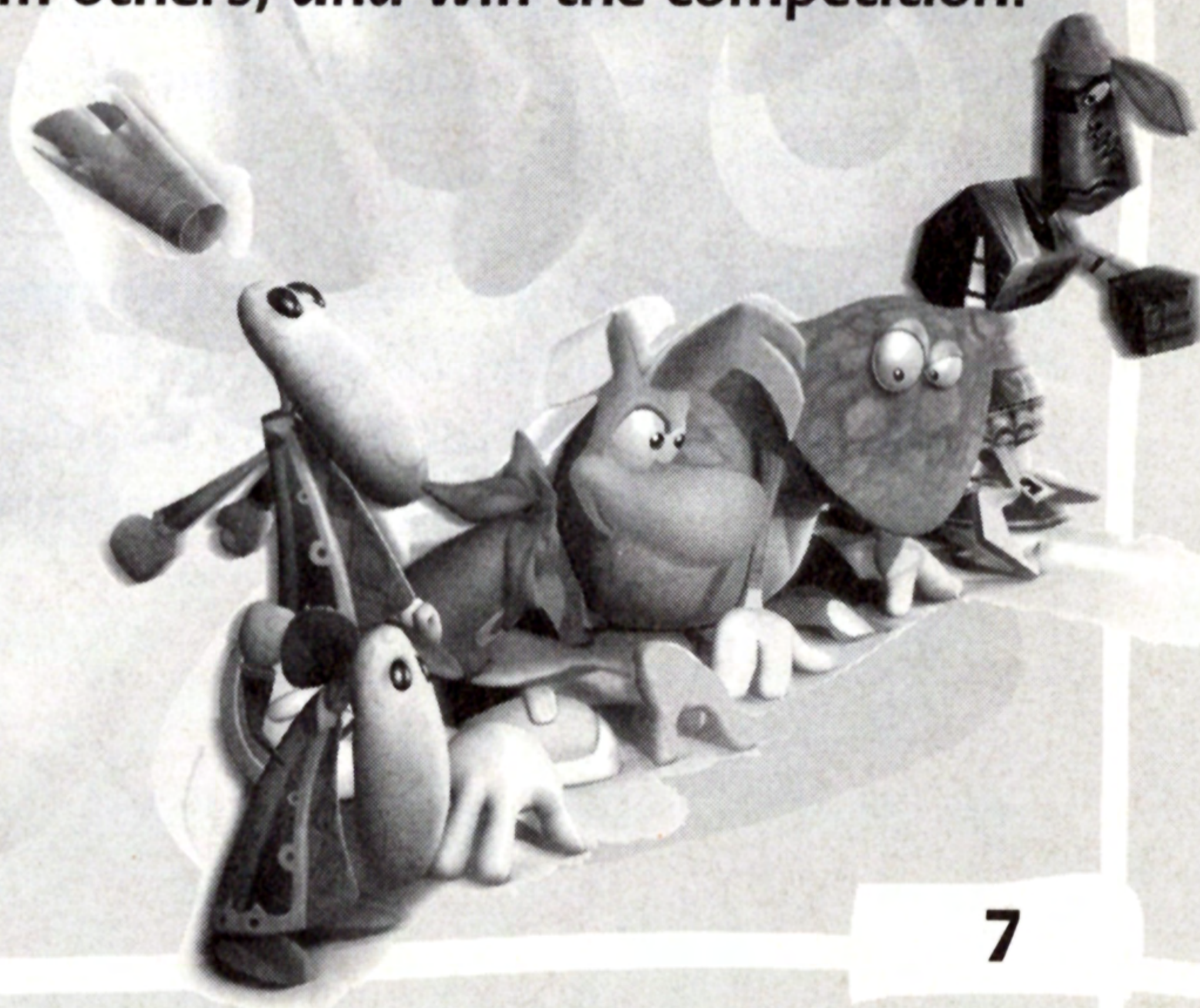



GAME RULES

A) GENERAL

The game is divided into 3 zones, each containing 4 race levels. For each level, you will be able to choose between various game modes:

- Training Mode
- Championship Mode
- Time Attack Mode
- Lums Mode
- Target Mode

At the beginning, only zone 0 is available. You will subsequently be able to access the following levels: Training Mode, Championship Mode, and Time Attack Mode.

The Lums Mode & Target Mode are unlocked automatically when you achieve enough victories in the different levels. The Championship Mode unlocks Lums Mode levels; the Lums Mode unlocks the Target Mode levels. You will be informed each time a new feature becomes available.

B) GAME MODE DESCRIPTIONS

■ Training Mode (Only in Single-Player)

This mode familiarizes you with the levels and allows you to practice and master the game controls and tricks before the real challenge begins. Please note that only the first 4 levels are available at the beginning of the game.

■ Championship Mode (Only in Single-Player)

In Championship Mode, you will compete with a computer-controlled character. You have to finish 3 laps first to win. One victory in Championship Mode unlocks the similar level in Lums Mode; one victory in Lums Mode unlocks the similar level in Target Mode.

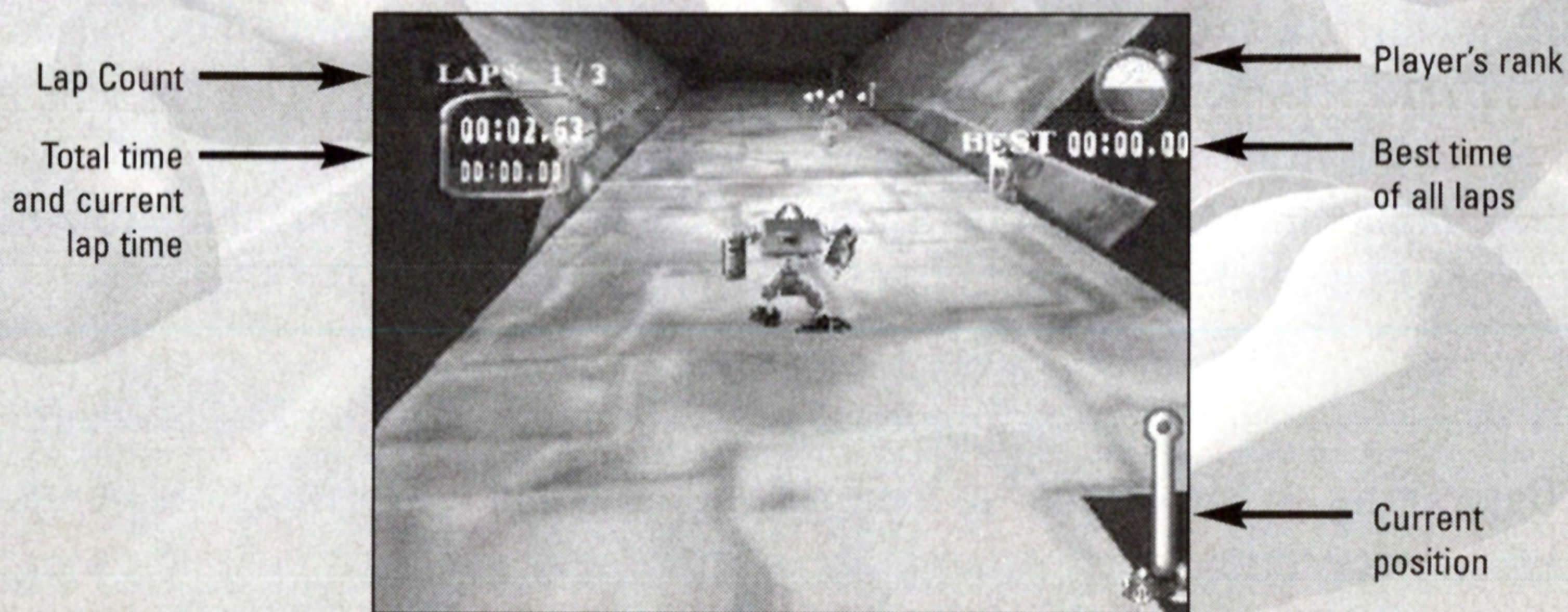

■ Time Attack Mode (Only in Single-Player)

Create the fastest lap record of the level!

You will run one lap on your own. The aim is to reach the next checkpoint before the timer reaches 0. If you can break the best lap time, your record will be saved into your profile.

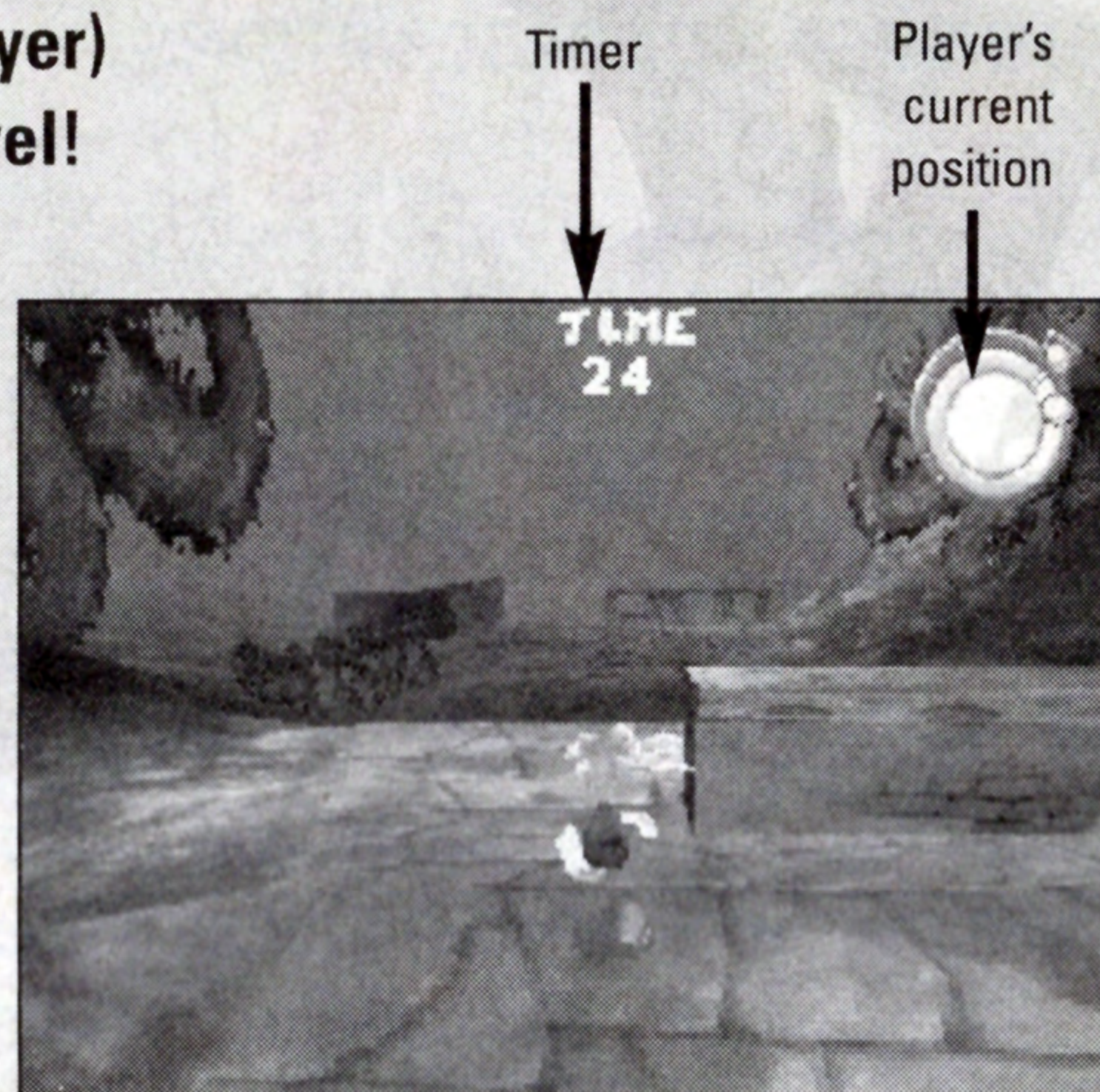

■ Lums Mode (Only in Single-Player)

Only available once the corresponding level has been unlocked in Championship Mode.

In this mode, many lums are spread around the maps. You must compete with a computer-controlled character and win the 3-lap race. At the same time, collect as many lums as possible.

➡ If you win, the corresponding level will be unlocked in the Target Mode.

➡ Depending on the number of lums you collect, you will win a time bonus for Target Mode.

Lap counter →
Freeze Power →



Lums left in this course

Player's current position

Lap time →

■ Target Mode (Only in Single-Player)

Only available once the corresponding level has been unlocked in Lums Mode.

You will be given a limited time to finish the race. Collect the butterflies spread around the level by shooting at them. Every butterfly you catch gives you extra time.

Lap counter →
Freeze Power →

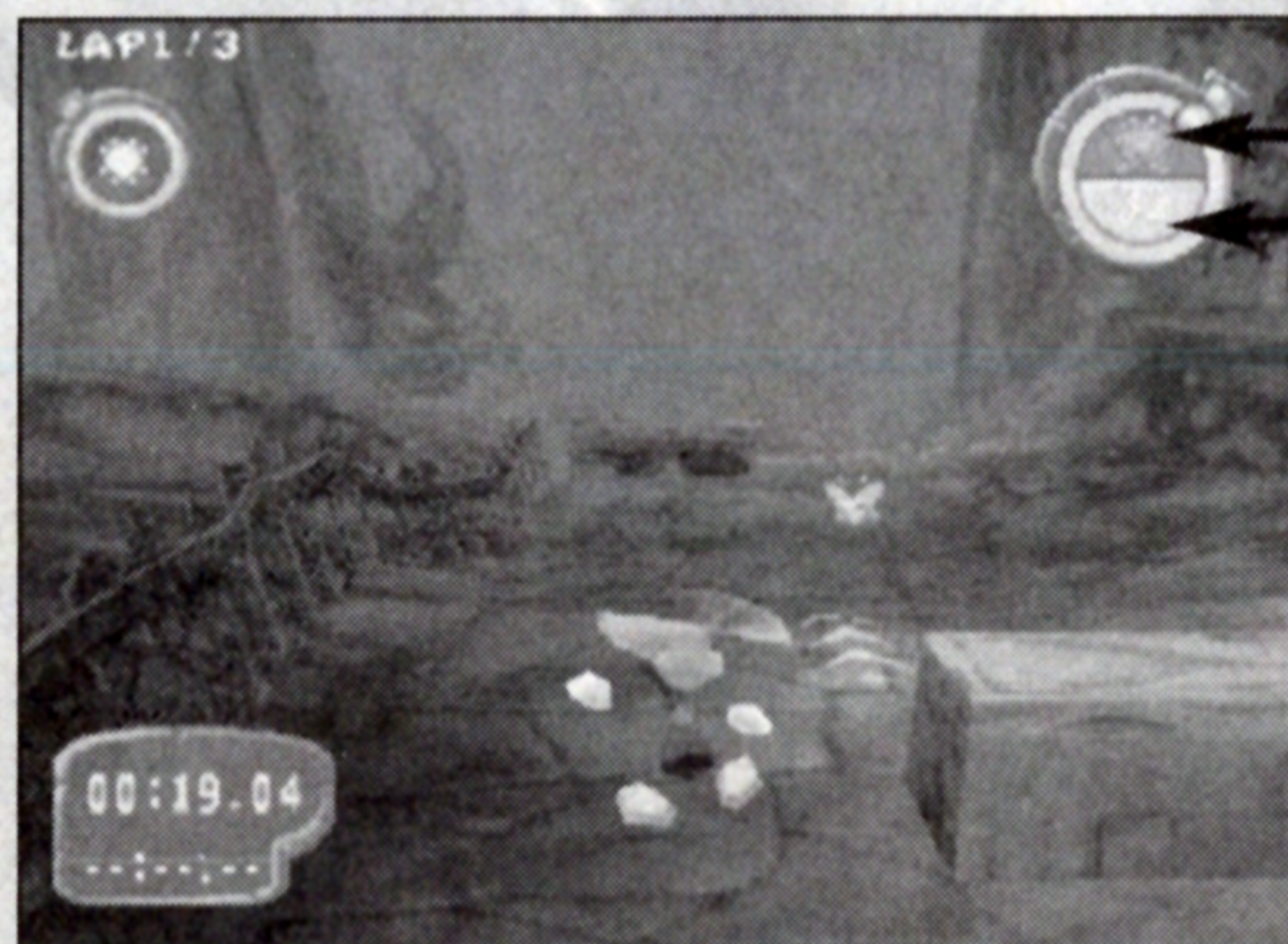

Targets left in this course

Player's current position

Timer →

➔ **PLAY IN SINGLE-PLAYER OR MULTIPLAYER**

NOTE: The Single-Player Game determines the way you progress through the game: your achievements in this mode will unlock levels, rewards & characters. In a Multiplayer Game, you can access the levels you have already unlocked in a Single-Player Game only.

A) RAYMAN RUSH CHARACTERS

➔ **Character Descriptions**

■ **Rayman:**

Although Rayman has no sleeves, he sure has plenty of tricks! Known for his heroism while protecting his friends, the “limbless wonder” forgets the meaning of friendship the minute he steps into the arena of competition. This is his turf, and he’s fiercely competitive when it comes to staying on top.

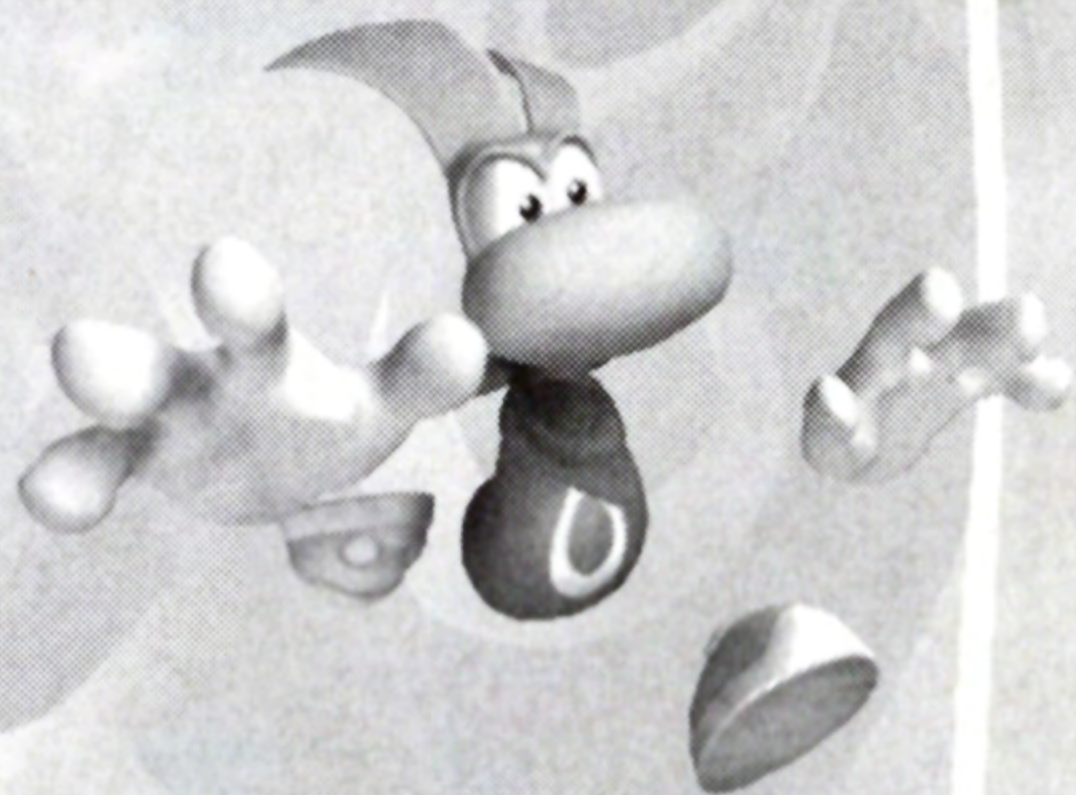

■ **Globox:**

Had to overcome his timidness and fear (maybe he’s had therapy?) to take part in this competition. While he might appear a bit awkward and clumsy, that oversized body hides a definite dexterity and fighting spirit.



■ **Razor Beard:**

Always angry, irritable, and mean. What he lacks in size, he makes up for in spite, making him a master of shots below the belt, which he likes more than anything else.

■ **Henchman 800:** A robot pirate's life is simple: be the best, waste others, beat them to a pulp if necessary, have no mercy...

Be tough enough and unlock the hidden characters....

■ **Mrs. Razorbeard:** Her more refined and fashionable appearance (sunglasses, dress, etc.) thinly veils the same traits as her horrible husband, only worse...

■ **Tily:** A slight, fragile and impish little fairy... until the race starts...

■ **Henchman 1000:** An older version of the robot pirate, more distinguished, but with the same values as Henchman 800: win, waste others...

■ **Globette:** As shy as her friend, she is yet a fierce competitor when it comes to racing. Globox himself is never sure he can defeat his beloved friend.



⇒ Character Selection

At the beginning, only 4 characters are available. The 4 hidden characters will be unlocked as you evolve in the game. In the Single-Player Game, use the directional buttons or the left analog stick to highlight your character selection and press the × button to validate your choice. In the Multiplayer Game, Player 2 presses the × button to join the game.

B) SINGLE-PLAYER GAME

Play on your own and improve your mastery of the environment to become faster and faster. In the main menu, select the Single-Player Game with the directional buttons or the left analog stick. Your selection will be highlighted. Press the × button to confirm your choice. Press the △ button to return.

⇒ Map Selection

To move from one zone to another, press the L1 button to move left and the R1 button to move right. Select your level with the left analog stick pressed left and validate by pressing the × button. You can now choose your game mode.

⇒ Game Mode Selection

You can choose between: Training Mode, Championship Mode, and Time Attack Mode. Select your mode with the LEFT/RIGHT directional buttons or the left analog stick.

Your selection is highlighted. Press the × button to validate your choice.

C) MULTIPLAYER

⇒ General

In the Multiplayer Game, challenge one friend in a 1, 3 or 5-lap race. Initially, only four levels in Zone 0 are available. Use your experience and knowledge of the environment! In the Multiplayer Game, only 2 players can play simultaneously.

Note: Player 1 controls menu navigation and confirms by pressing the × button.

⇒ Level Settings

You can determine the victory settings with the left analog stick.

- Select the number of laps required to win: 1 / 3 / 5

Validate by pressing the × button.

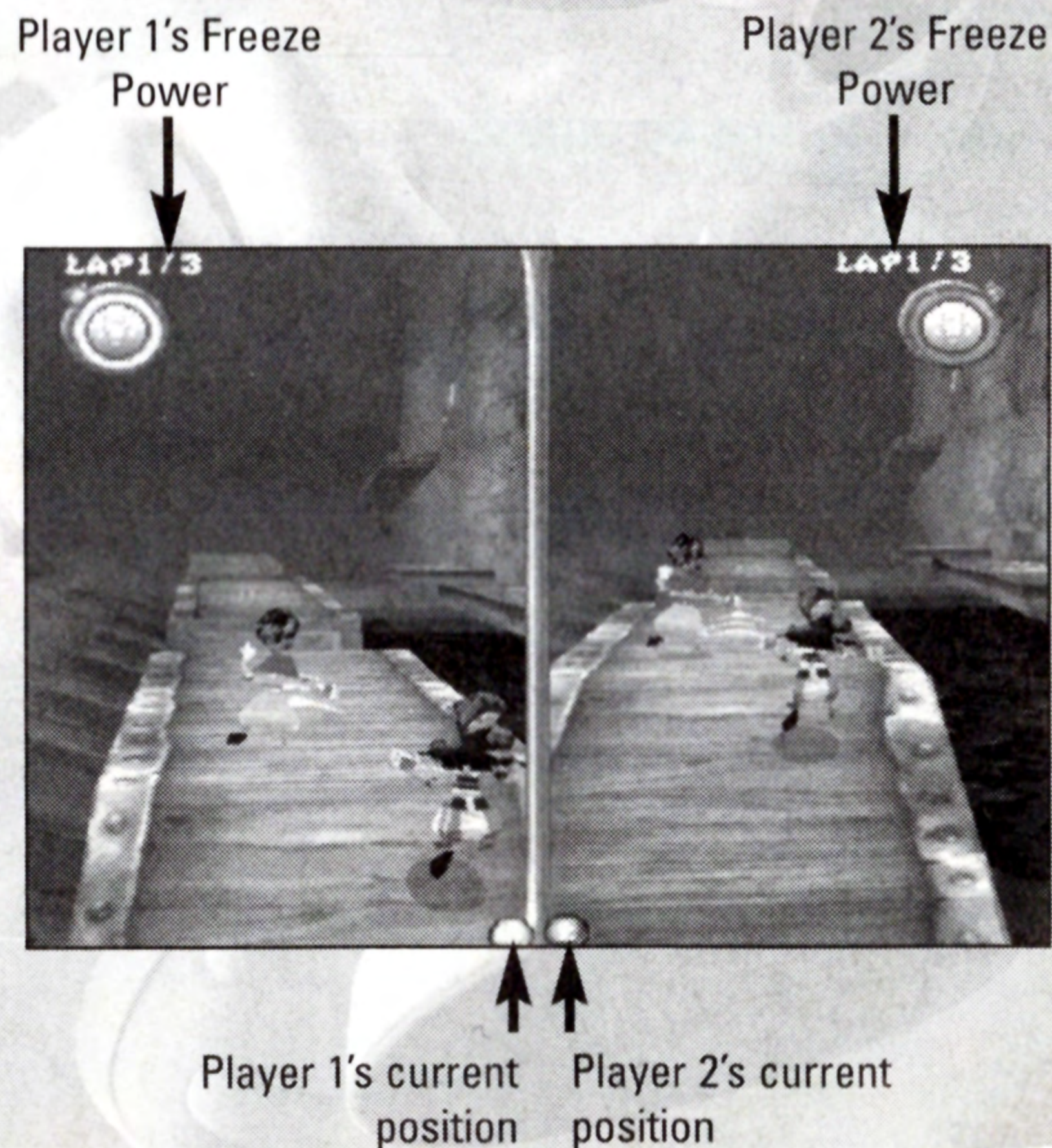



CREDITS

Ubi Soft Project Management

Original Concept

Michel Ancel & Frederic Houde

Studio Managers

Weng Ying Ming

China - Managing Director

Weng Ying Ming

China - Software Studio

Managers

Olivier Chappe, Chen Shen Feng

China - Design Studio

Manager

Ye Wei

China - Graphic Studio Manager

Jean-Michel Tari

China - Animation Manager

Gu Jie

China - Sound Design Studio Manager

Adrian Jones

China - Data Management Studio

Manager

Zong Jin

China - Test Studio Manager

Bai Hai Lei

China - Planning Studio Manager

Lan Hai Wen

Studio General Manager

Corinne Le Roy

Ubi Soft Creation Team

Project Manager

Lu Zhi Gang, He Jun Xian

Programming

Lead Programmer

Xu Xiao Yue

Programmer

Chen Hai, Qiu Li, He Zhi Ming, Sun Ting

Game Design

Lead Game Designer

Shui Xiu Yi

Game Designer

Shen Ye Tao, Wu Yi Dong,
Yan Zhao Xiang

Info Design

Lead Info Designer

Zhou Jing

Info Designer

Cao Hai Ying, Wang Jun,
Qu Wen Hao, Mu Hong

Animation

Lead Animator

Li Wei

Animator

Ding Wei, Huang Zhi Qing

Special Effects

Shou Jia An

Graphics

Lead Graphic

Yang Bo

Characters

Yao Chao Yang

Maps

Yao Wei Jun, Gu Qiang, Chen Qing,
Chen Jing, Wang Zheng, Sun Jie Han

Sketch

Fan Yu Qing

Sound

Sound Design

Bao Qing Ming

Sound Engineer

Sun Ting

Sound Technical Advisor



Yang Jie

Data Manager

Liu Jia Tao

Localization

Translation Manager

Jean-Sebastien Ferey

Cinematics

Cinematics Studio Manager

Sophie Penziki

Direction & Storyboard

Mathieu Breda

3D Rendering Graphic Artists

Corinne Bouvier, Yann Jouette

SFX Rendering

Charles Bernaeirt

Animation

Thomas J Anderson, Steve Ouellet,
Erik Branz

Audio Production

Sound Producer

Sylvain Brunet

Creative Manager

Manu Bachet

Sound Production Organization

Marine Lelievre

Voice Director

Eddie Crew

Voices

Lee DeLong, Joddie Forrest, David
Gasman, Joe Sheridan, Ken Starcevic

Recorded by

Lionel Bouhnik at Ubi Sound Studios
France

Sound Effects by

Talkover

Music Composed,

Arranged and Performed by

Claude Samard

Additional Arrangements by

Bernard H. Levitte

Mixed by

Martin Dutasta at Ubi Sound
Studios France

Gameslab

Sophie Rouquette, Lionel Raynaud,
Fanny Georges

Test

Chief Tester

Zhu Kai

Testers

Xu Ming, Li Xi Yun, Cai Bei Lei,
He Lei, Zhu Jia An, Hu Di Yun, Chai
Ze Hua, Li Jing Quan,
Shi Guo Hua

Planning

Lu Wei Xin



Publisher: Ubi Soft Entertainment

CEO

Yves Guillemot

International Production Director

Christine Burgess-Quemard

International Content Director

Serge Hascoet

International Content Manager

Gunther Galipot

Approval Coordinators

Nikola Milisavljevic, Willie Wareham

Marketing Teams

EMEA Marketing

Domitille Doat, Géraldine Durand,
Antoine Valton (EMEA)
Valeria Lodeserto (ITA)
Susie Frevert (UK)

Thorsten Kapp (GER)

Eva Duran (SP)

Marcel Keij (NL)

Coppelia Mille (FR)

Kristina Mortensen (Scandinavia)

Soren Lass (Scandinavia)

Vanessa Leclercq (Benelux)

Vera Shah

US Marketing

Mona Hamilton, Danny Ruiz

Special Thanks to:

Jean-Christophe Guyot, Hirofumi
Motoyama, Liu Jing, Yang Jin,
Yuan Pei Sheng

Rayman®2002 Ubi Soft, Inc. Ubi Soft Entertainment is a trademark of Ubi Soft, Inc. Rayman, Ubi Soft, and the Ubi Soft Entertainment logo are registered trademarks of Ubi Soft, Inc. All rights reserved. PlayStation and the PlayStation logos are registered trademarks of Sony Computer Entertainment, Inc.

NOTES



PROOF OF PURCHASE



Rayman[®] Rush

NOTES

NOTES



TECHNICAL SUPPORT

Before contacting Ubi Soft Technical Support, please carefully read through this manual. Also, help is available online at <http://www.ubi.com/support>. If you are unable to find an answer to your question using the website or the manual, please contact us via one of the following methods:

CONTACT US OVER THE INTERNET:

<http://www.ubi.com/support>

This site takes you to the Ubi Soft Solution Center. Here you can browse our FAQ listings, or search the solution database for the most recently updated information since the game's release. Or, for fastest email response, you can send in a request for Personal Assistance from a Technical Support Representative.

CONTACT US BY E-MAIL:

For fastest response via e-mail, please visit our website at: <http://www.ubi.com/support>.

From this site, you can enter the Ubi Soft Solution Center where you can send in a request for Personal Assistance from a Technical Support Representative. You can also contact our Ubi Soft Support by e-mailing them directly at: support@ubisoft.com.

It may take anywhere from 24-72 hours for us to respond to your e-mail depending upon the volume of messages we receive and the nature of your problem.

CONTACT US BY PHONE:

You can also contact us by phone by calling (919) 460-9778. Note that this number is for technical assistance only. We cannot give hints or tips over the Technical Support line. When calling our Technical Support line, please make sure you are at the game. Be advised that our Technical Support Representatives are available to help you Monday - Friday from 9 am - 9 pm (Eastern Standard Time), excluding holidays. While we do not charge for technical support, normal long distance charges apply. To avoid long distance charges, or to contact a support representative directly after these hours, please feel free to use one of the other support avenues listed above. E-mail responses usually receive a response in less than 2 business days. If we receive your e-mail, you will receive a response!

CONTACT US BY STANDARD MAIL:

Please do not send returns directly to Ubi Soft without first contacting a Technical Support Representative. If you need to return a product, review the Replacement policy/Warranty in this manual.

UBI SOFT LIMITED WARRANTY

Ubi Soft warrants to the original purchaser of its products that the products would be free from defects in materials and workmanship for a period of ninety (90) days from the date of purchase. Ubi Soft products are sold "as is", without any expressed or implied warranties of any kind, and Ubi Soft is not liable for any losses or damages of any kind resulting from use of its products. Ubi Soft agrees for a period of ninety (90) days to either replace defective product free of charge provided you return the defective item with dated proof of purchase to the store from which the product was originally purchased or repair or replace the defective product at its option free of charge, when accompanied with a proof of purchase and sent to our offices postage prepaid. This warranty is not applicable to normal wear and tear, and shall be void if the defect in the product is found to be as a result of abuse, unreasonable use, mistreatment or neglect of the product.

LIMITATIONS

This warranty is in lieu of all other warranties and no other representations or claims of any nature shall be binding on, or obligate Ubi Soft. Any implied warranties applicable to Ubi Soft products, including warranties of merchantability and fitness for a particular purpose, are limited to the ninety (90) day period described above. In no event will Ubi Soft be liable for any special, incidental, or consequential damages resulting from possession, use, or malfunction of Ubi Soft products. Some states do not allow limitations as to how long an implied warranty lasts and/or exclusions or limitations of incidental or consequential damages. So the above limitations and/or exclusions of liability may not apply to you. This warranty gives you specific rights, and you may also have other rights that vary from state to state.

NOTICE

Ubi Soft reserves the right to make improvements in its products at any time and without notice.

REFUNDS

Ubi Soft cannot provide refunds or otherwise process returns for credit of any kind other than an identical product replacement. Any product refund request must occur at the place of purchase, as the individual retail outlets set their own refund policy. This policy covers identical product replacements only.

PRODUCT / DOCUMENTATION REPLACEMENTS

Please contact Ubi Soft Technical Support before sending your product to us. In many cases, a replacement is not the best solution. Our support representatives will help you determine if a replacement is necessary or available.

Within the 90-day warranty period:

Please return the product (media only) along with a copy of the original sales receipt, showing the date of purchase, a brief description of the difficulty you are experiencing including your name, address and phone number to the address below. If the product was damaged through misuse or accident, or if you do not have a dated sales receipt, then this 90-day warranty is rendered void and you will need to follow the instructions for returns after the 90-day warranty period.

AFTER THE 90-DAY WARRANTY PERIOD:

Please return the product (media only) along with a check or money order for the amount corresponding to your product (see replacement fees below) made payable to Ubi Soft, a brief description of the difficulty you are experiencing including your name, address and phone number to the address below.

REPLACEMENT FEES

Our most recent replacement fee schedule is available online. Please visit the support section of <http://www.ubisoft.com> for an updated price list.

Warranty Address and Contact Information

Email: replacements@ubisoft.com

Phone: 919-460-9778

Hours: 9am – 9pm (EST), M-F

Address:

Ubi Soft Replacements

2000 Aerial Center Pkwy, Ste 110

Morrisville, NC 27560

* Please use a traceable delivery method when sending products to Ubi Soft.



RAYMAN[®]

→ RUSH



Ubi Soft Entertainment, Inc. 625 Third Street, 3rd Floor, San Francisco, CA 94107 MADE IN USA.
Rayman©2002 Ubi Soft, Inc. Ubi Soft Entertainment is a trademark of Ubi Soft, Inc. Rayman, Ubi Soft, and the Ubi Soft Entertainment logo are registered trademarks of Ubi Soft, Inc. All rights reserved.

Licensed by Sony Computer Entertainment America for use with the PlayStation game console. PlayStation and the PlayStation logos are registered trademarks of Sony Computer Entertainment Inc. The ratings icon is a trademark of the Interactive Digital Software Association. Manufactured and printed in the U.S.A. THIS SOFTWARE IS COMPATIBLE WITH PLAYSTATION GAME CONSOLES WITH THE NTSC U/C DESIGNATION. U.S. AND FOREIGN PATENTS PENDING.

